

**ATTENTION**

Avant de retourner ce produit pour quelque raison qu'il soit (problème d'installation, consignes d'utilisation, panne, problème de fabrication...), merci de nous contacter.

Contact :

Vous pouvez nous joindre par mail à sav@clas.com ou bien au 04 79 72 92 80 ou encore vous rendre directement sur notre site clas.com

Si vous avez changé d'avis concernant votre achat, veuillez retourner ce produit avant d'essayer de l'installer.

WARNING

Before returning this product for any reason (installation problem, instructions for use, breakdown, manufacturing problem...), please contact us.

Contact :

You can reach us by mail sav@clas.com or by phone +33(0)4 79 72 69 18 or go directly to our website clas.com

If you have changed your mind regarding your purchase, please return this product before you attempt to install it.

REGLAGES

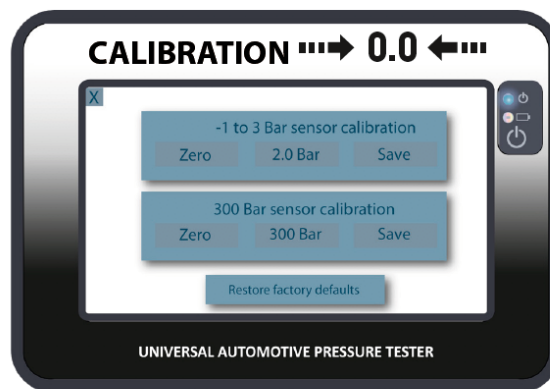
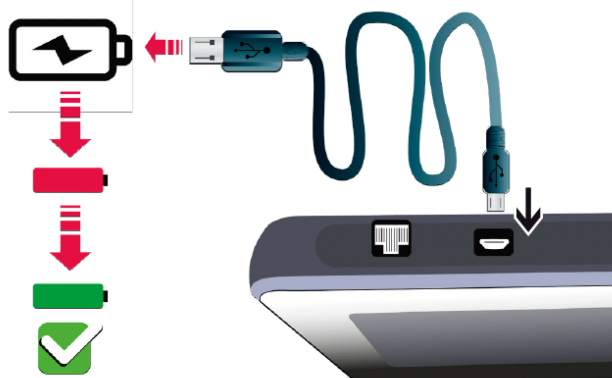
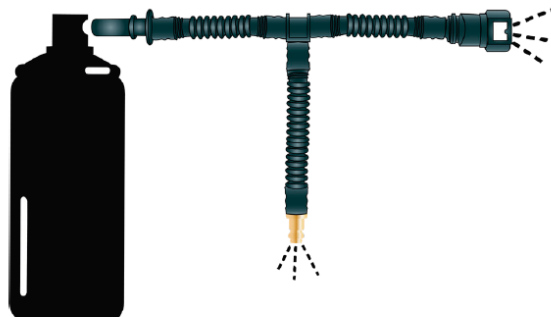
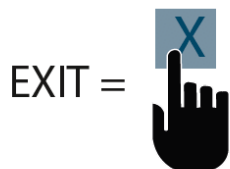

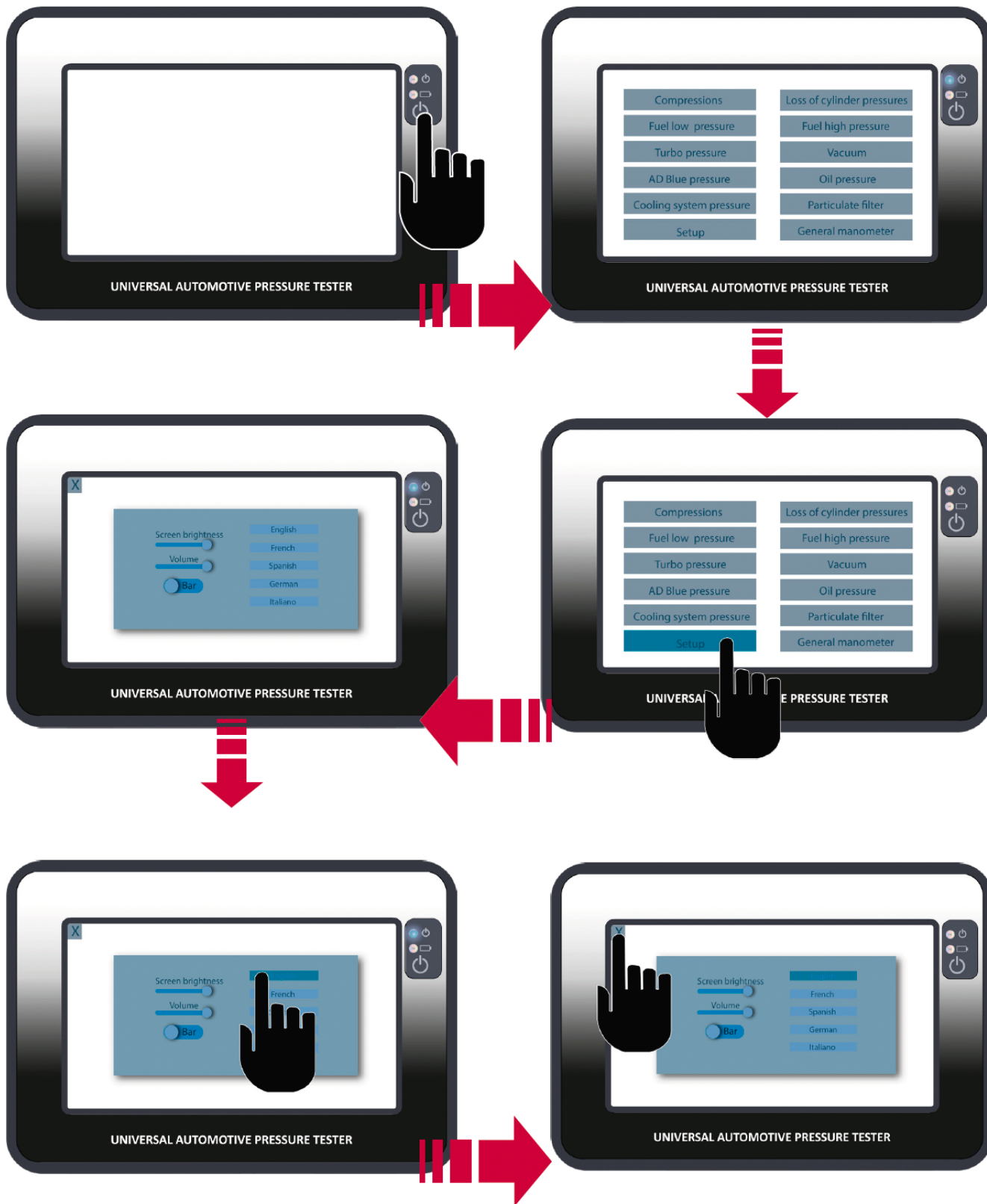

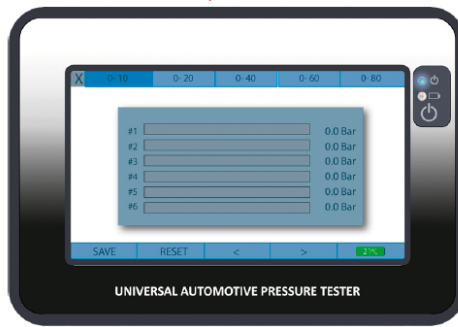
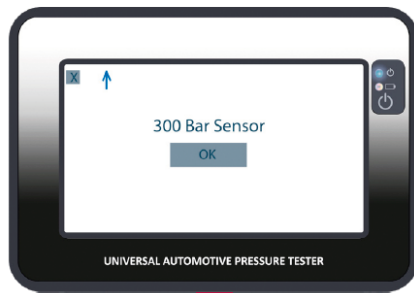
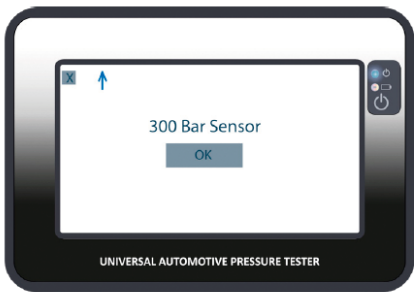
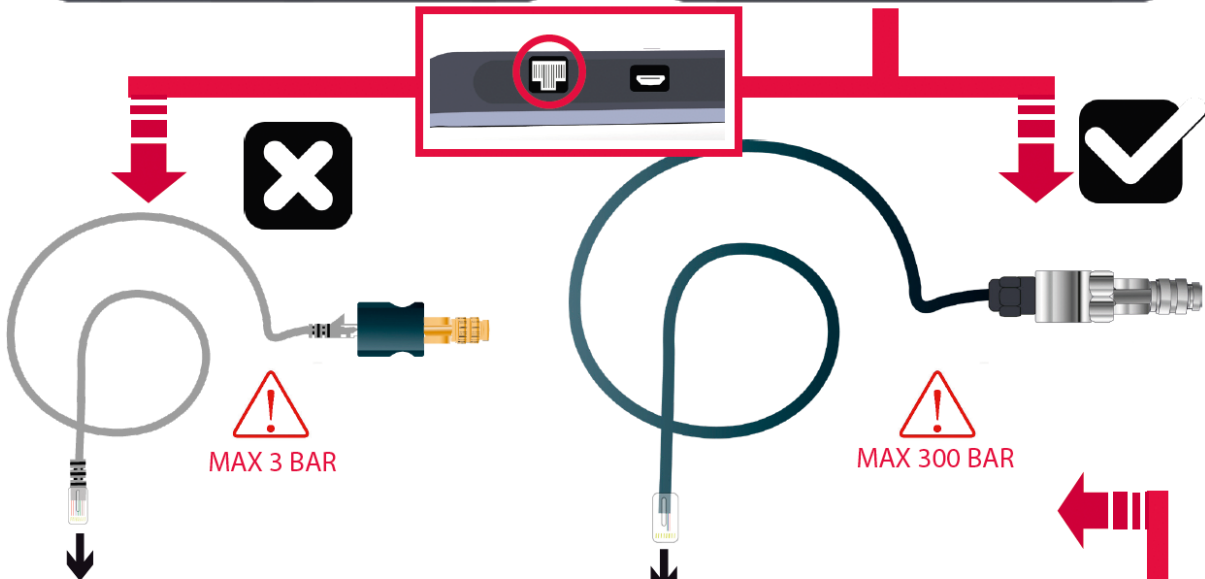
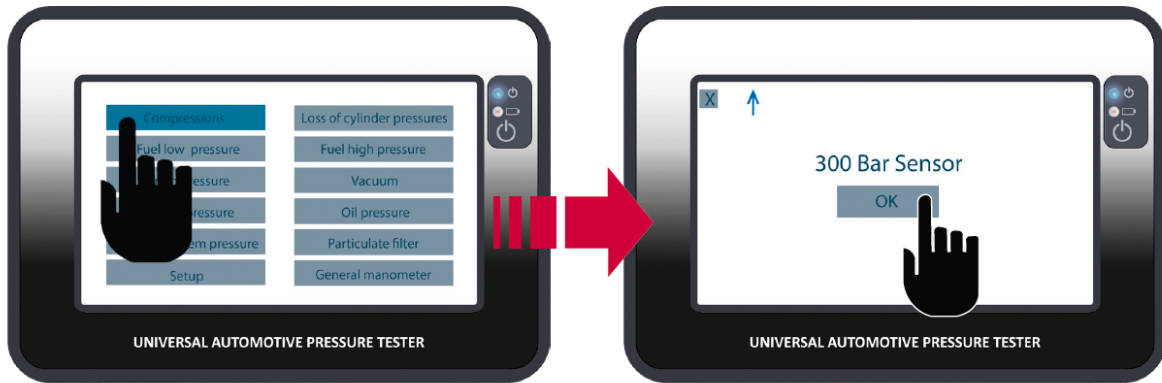

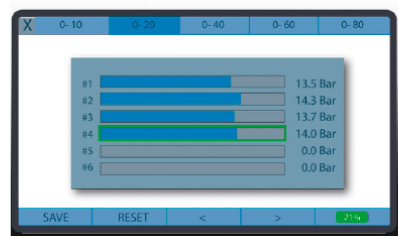
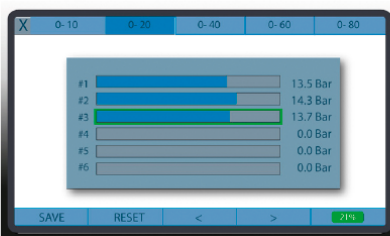
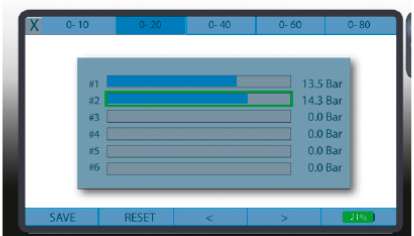
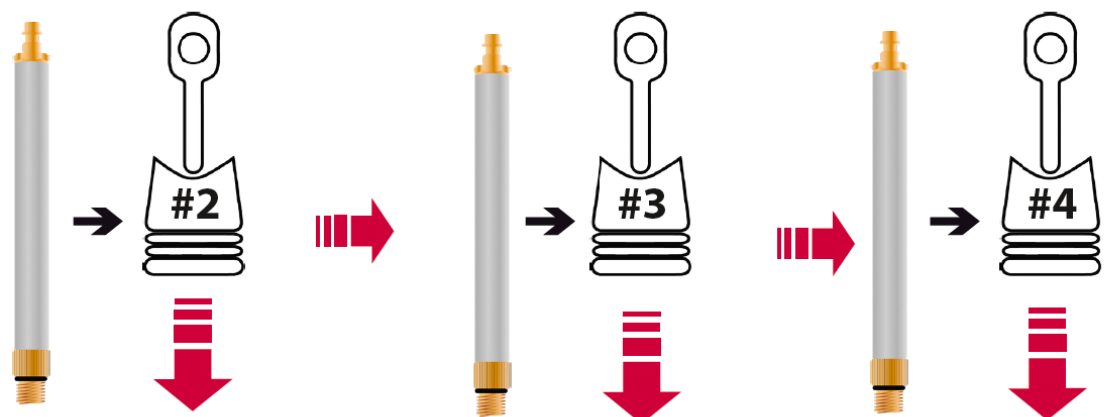
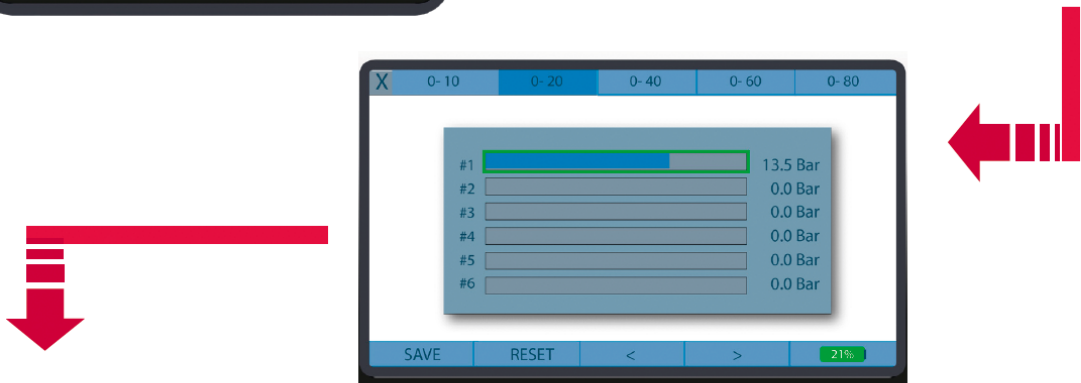
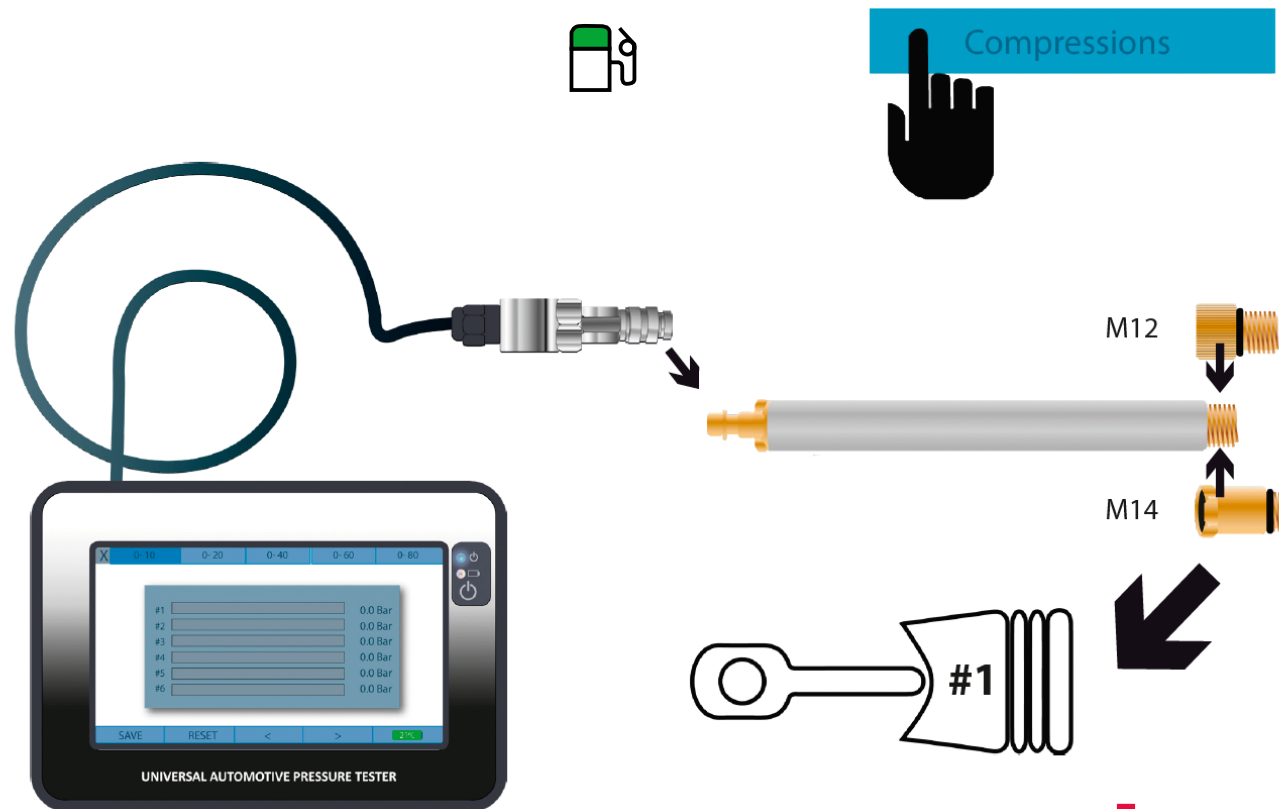

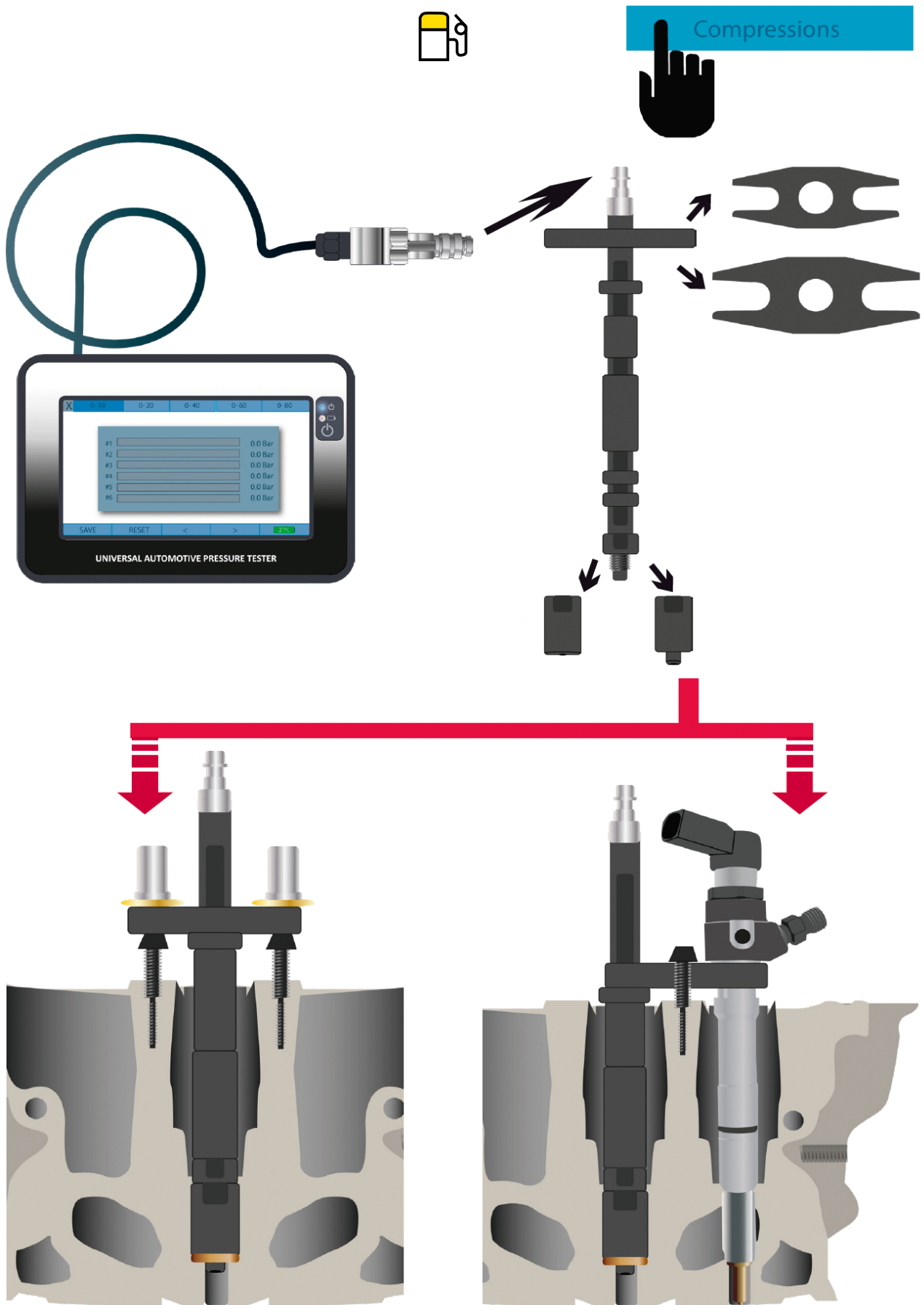

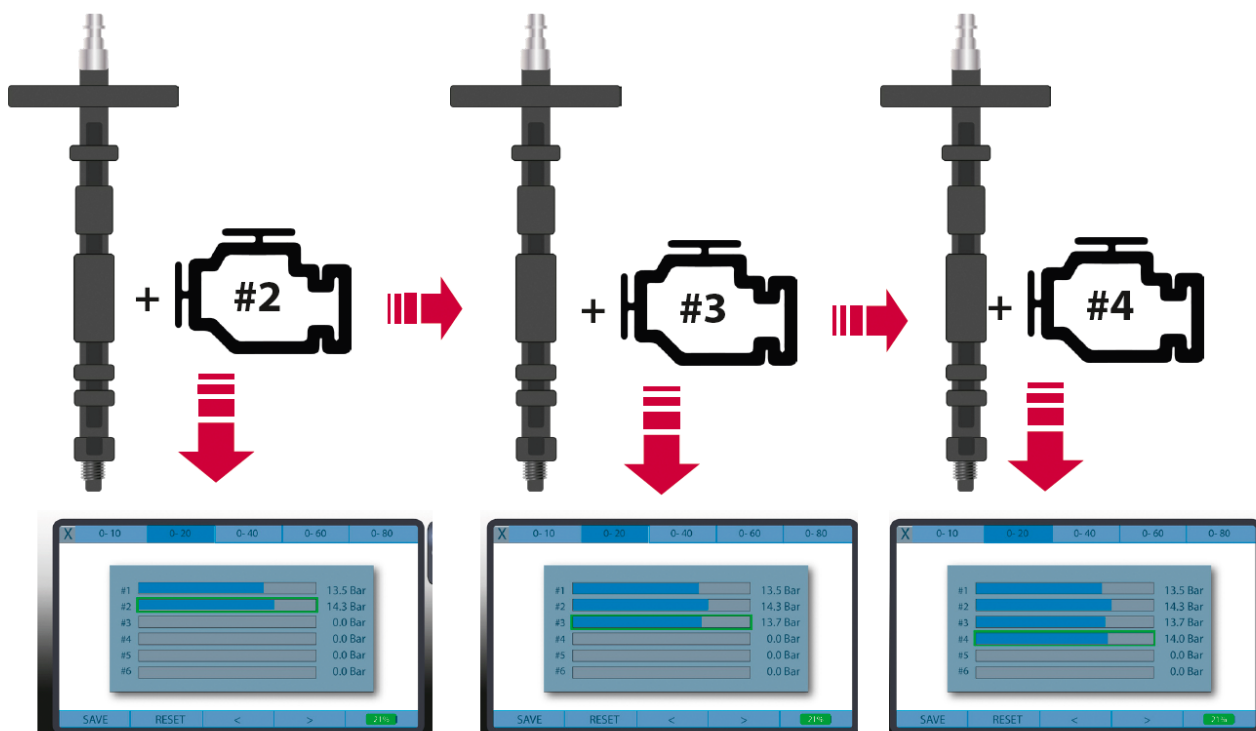
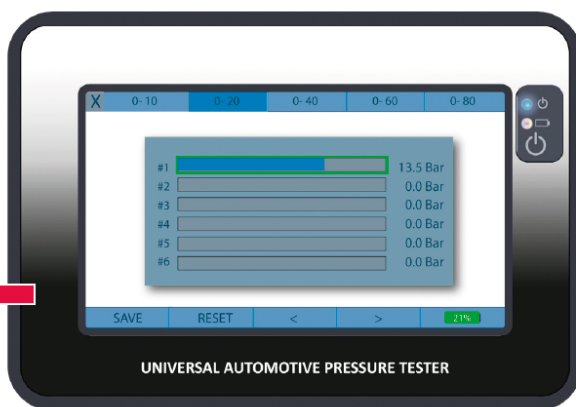
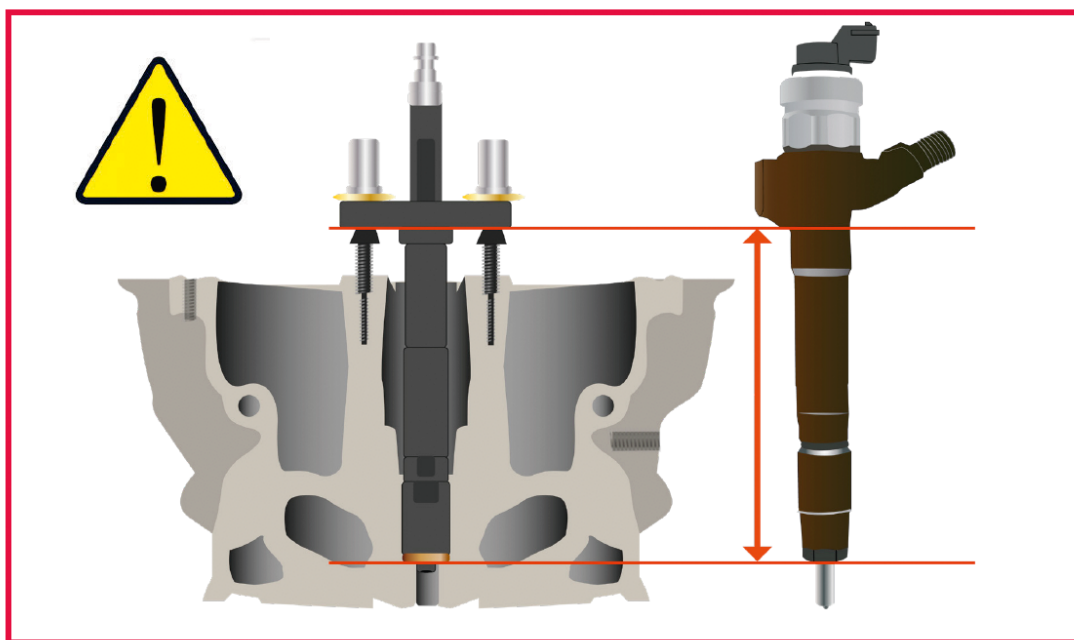

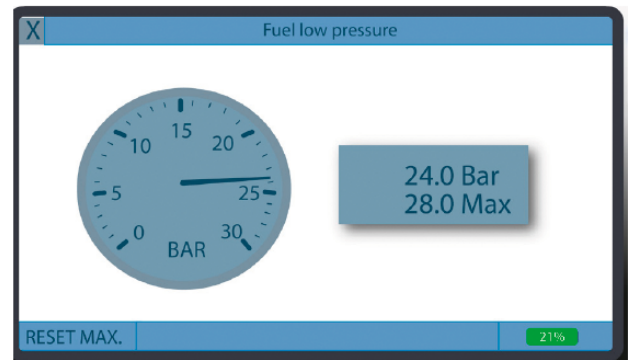
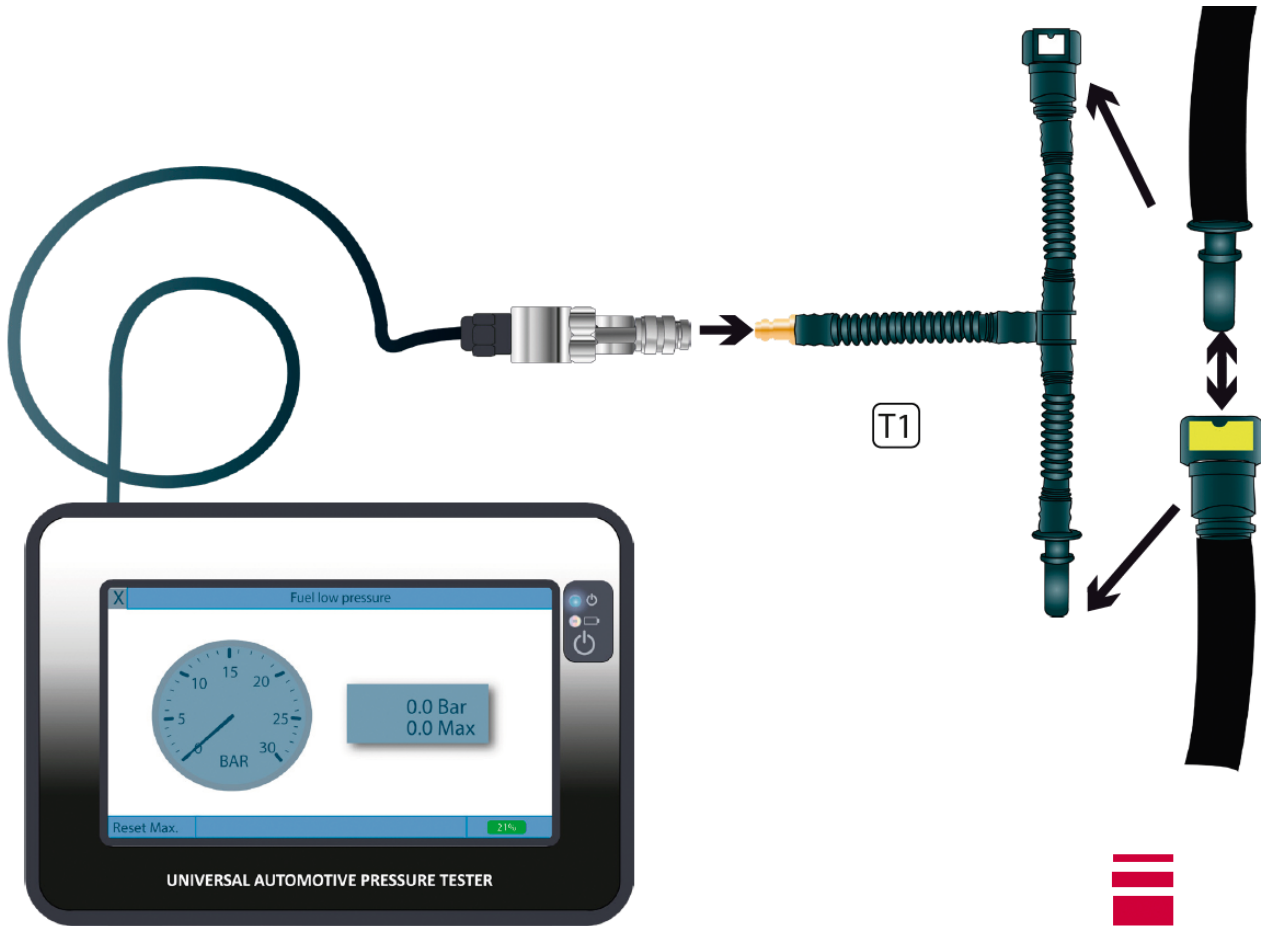



Turbo pressure

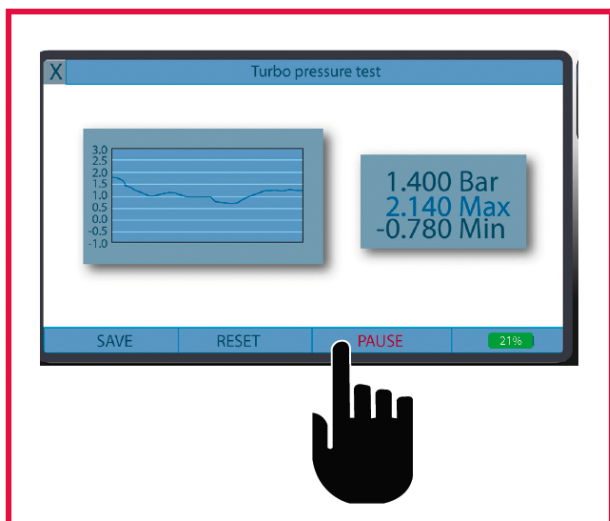
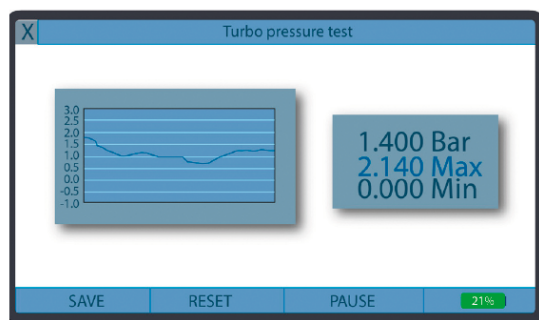
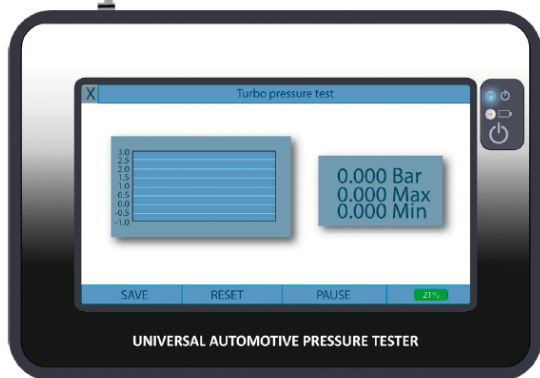
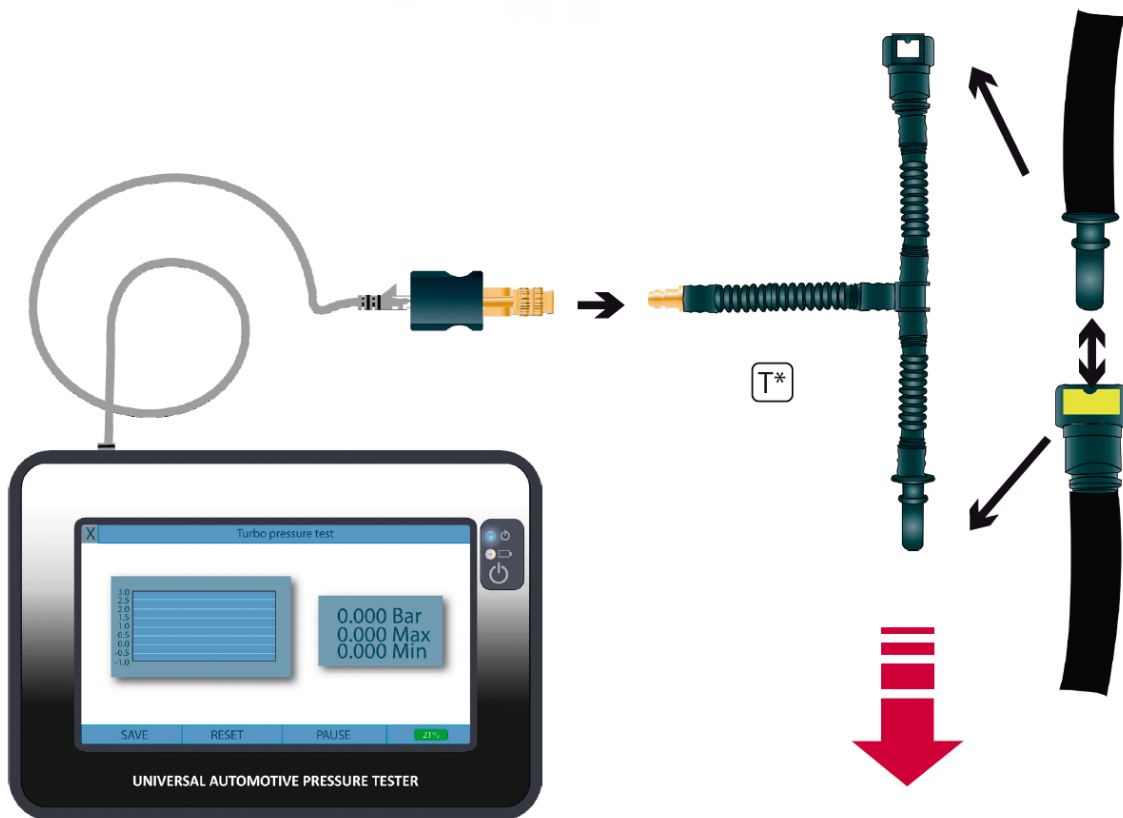

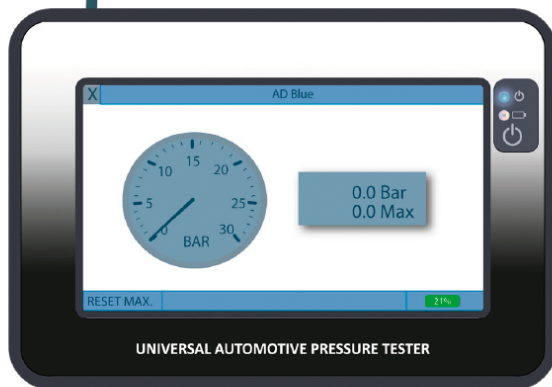
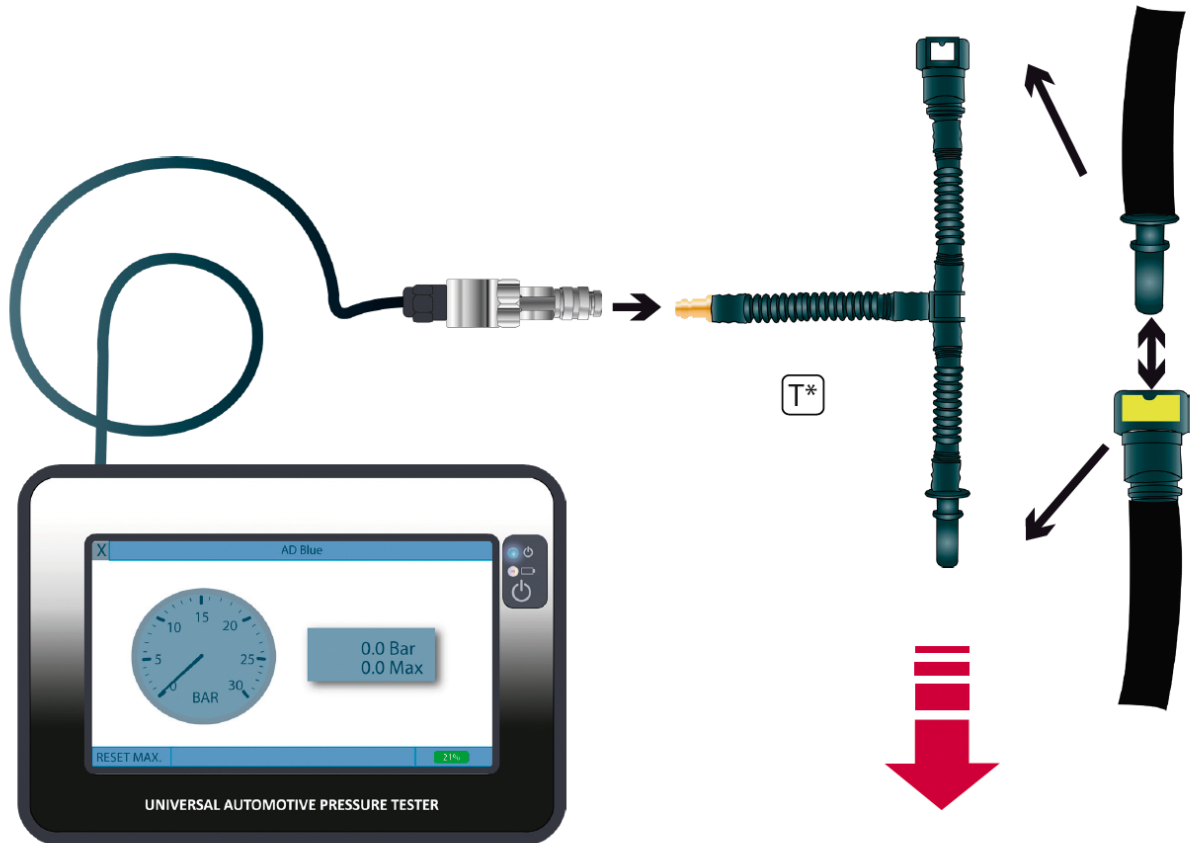

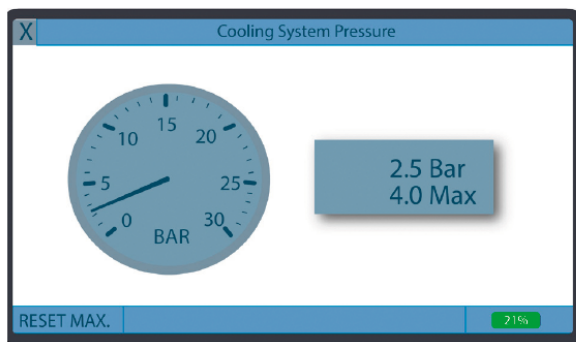
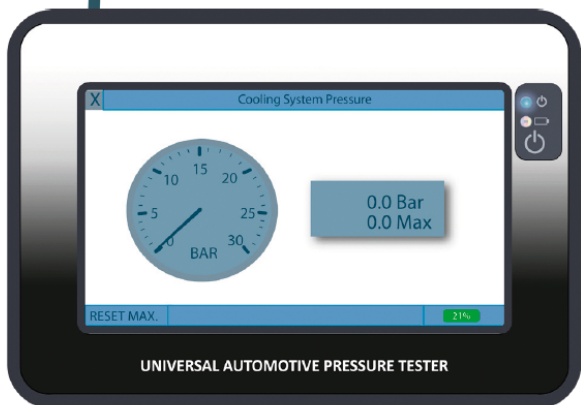
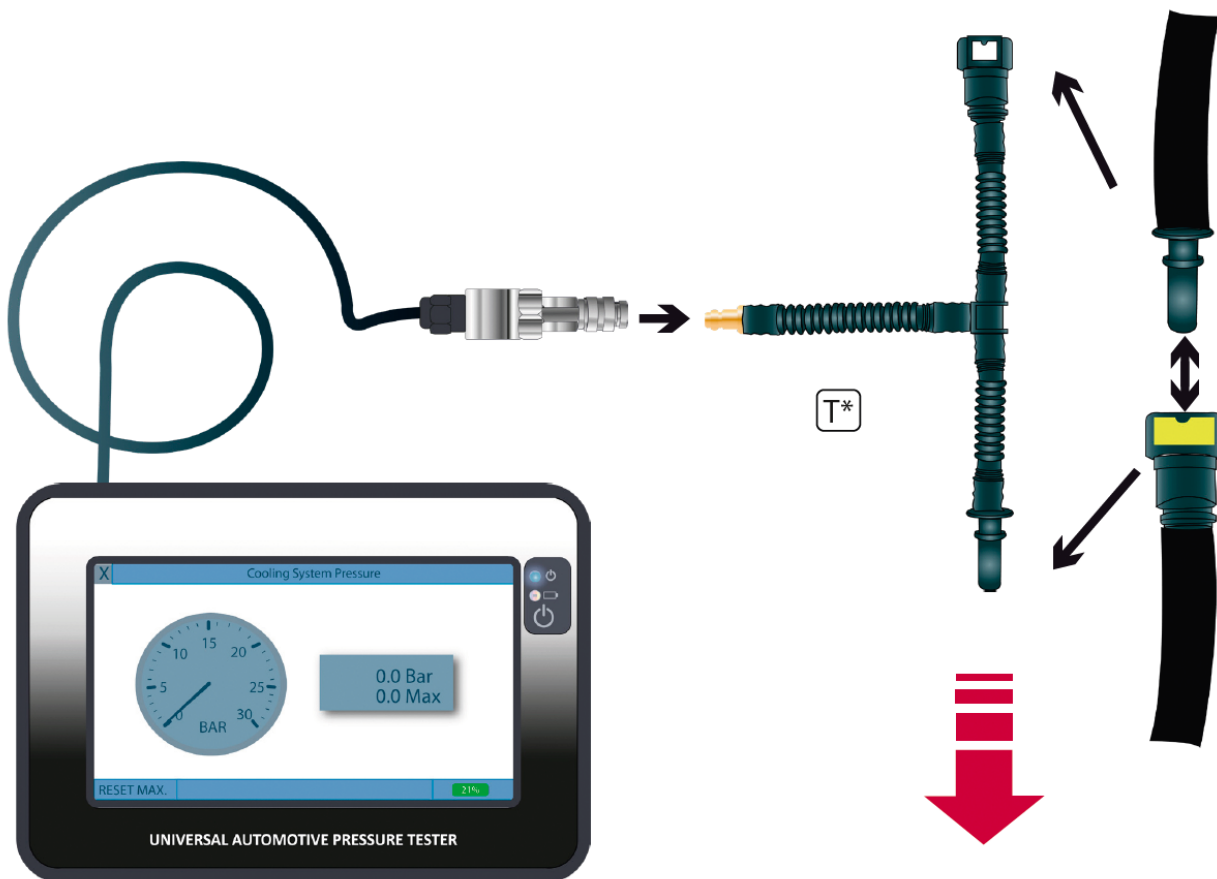

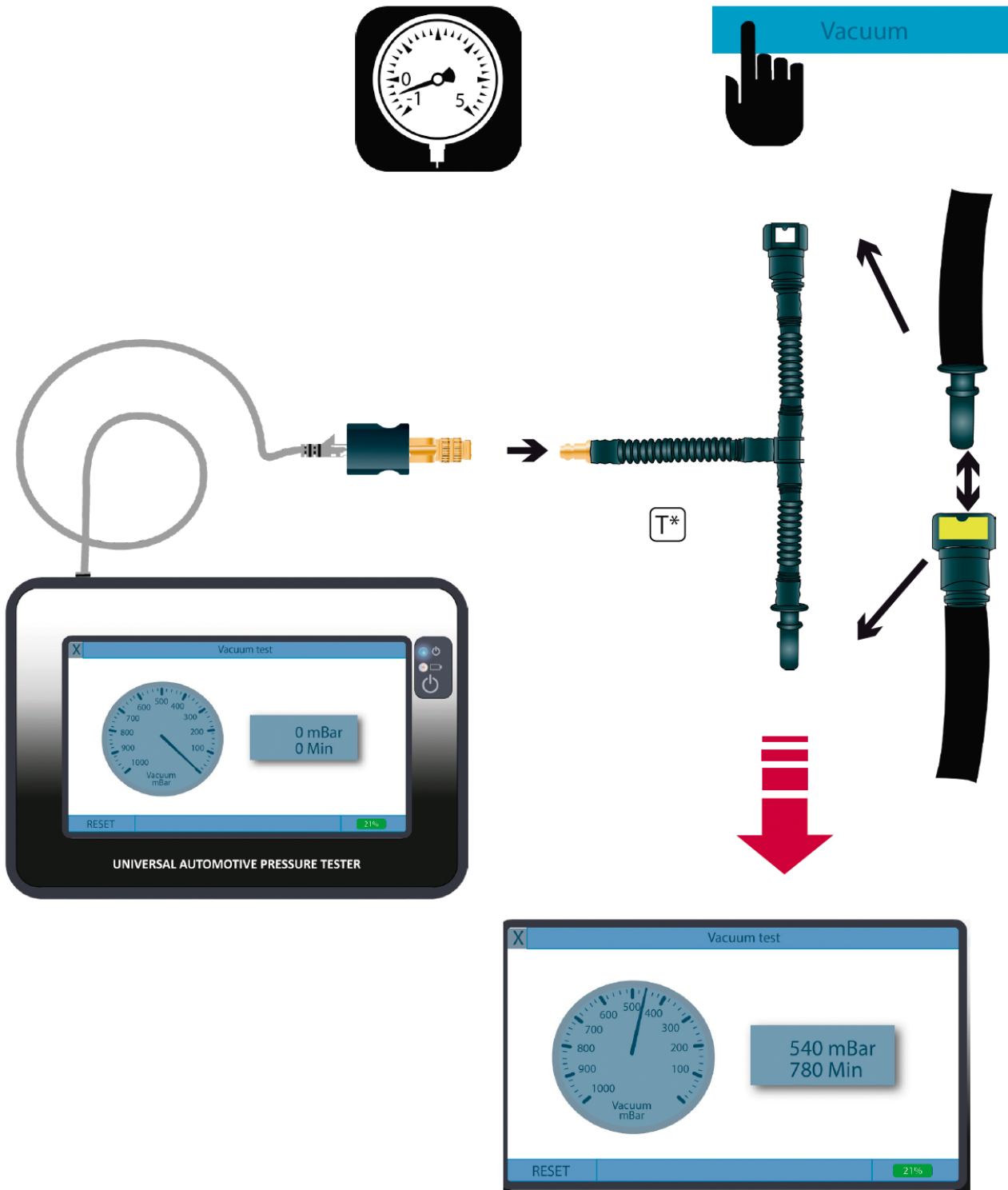

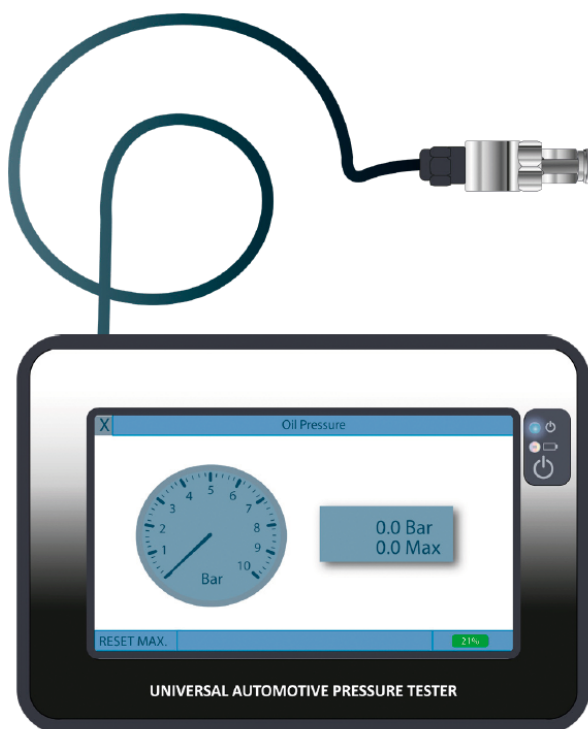

T*

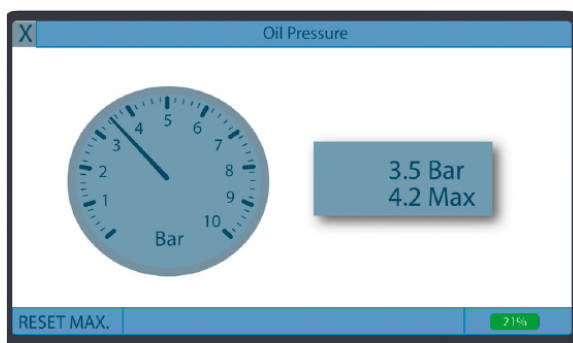
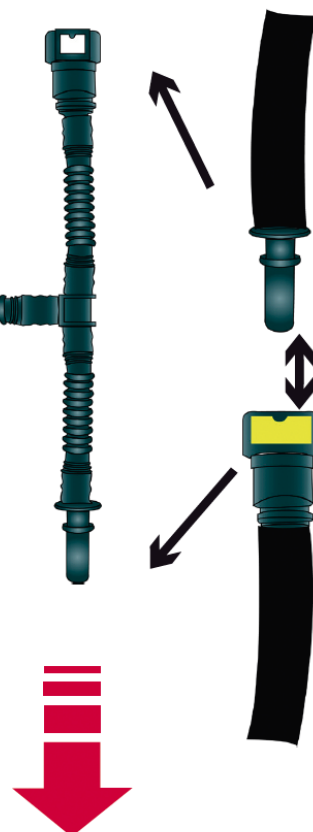



Particulate filter

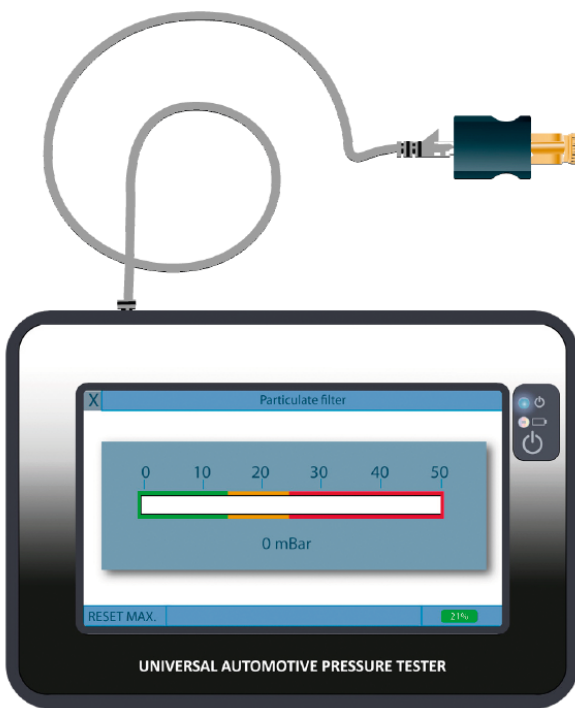

T*

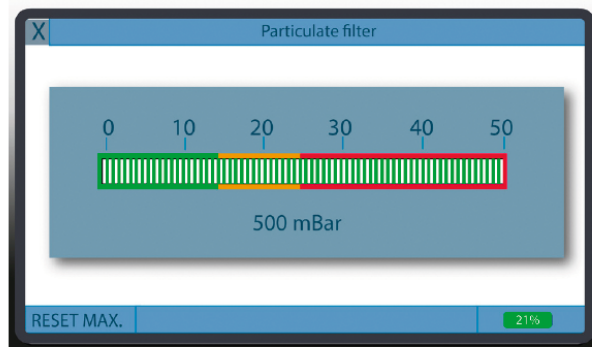
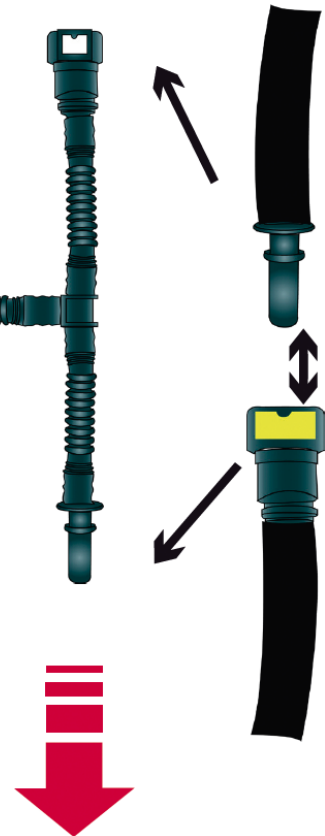



CONNEXIONS

T1



T2

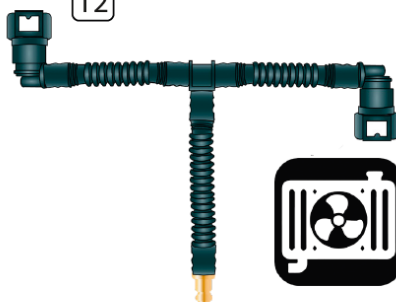

T3

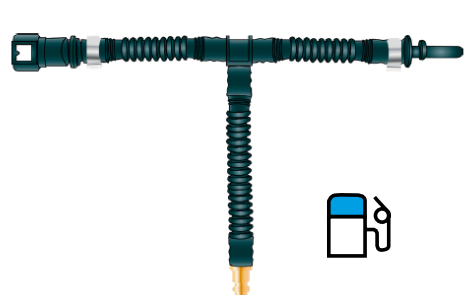

T4



T5

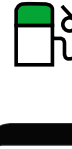

T6



T7

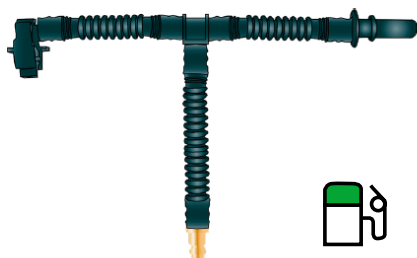

T8

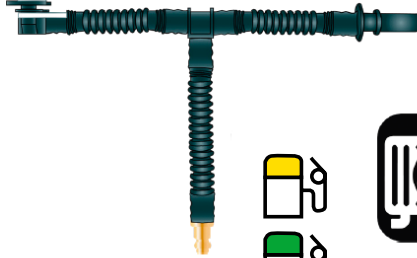

AD Blue



Diesel



Essence - Gasoline

UTILISATION DE LA VALVE - VALVE UTILISATION



Essence - Gasoline

Compressions

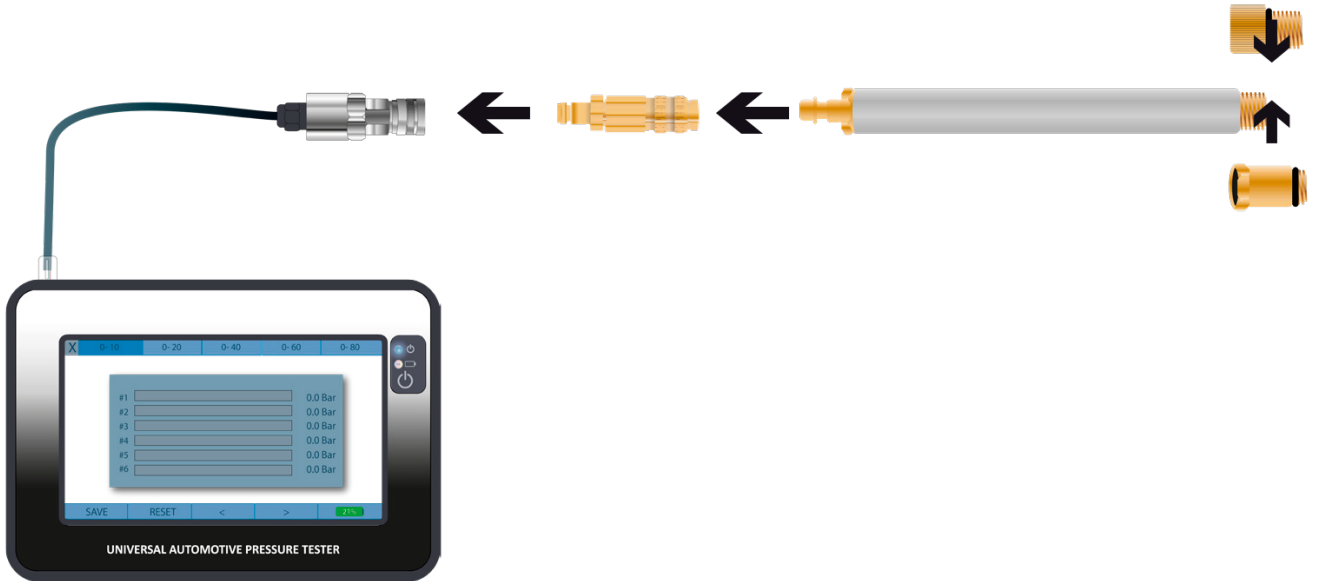

Diesel

Compressions

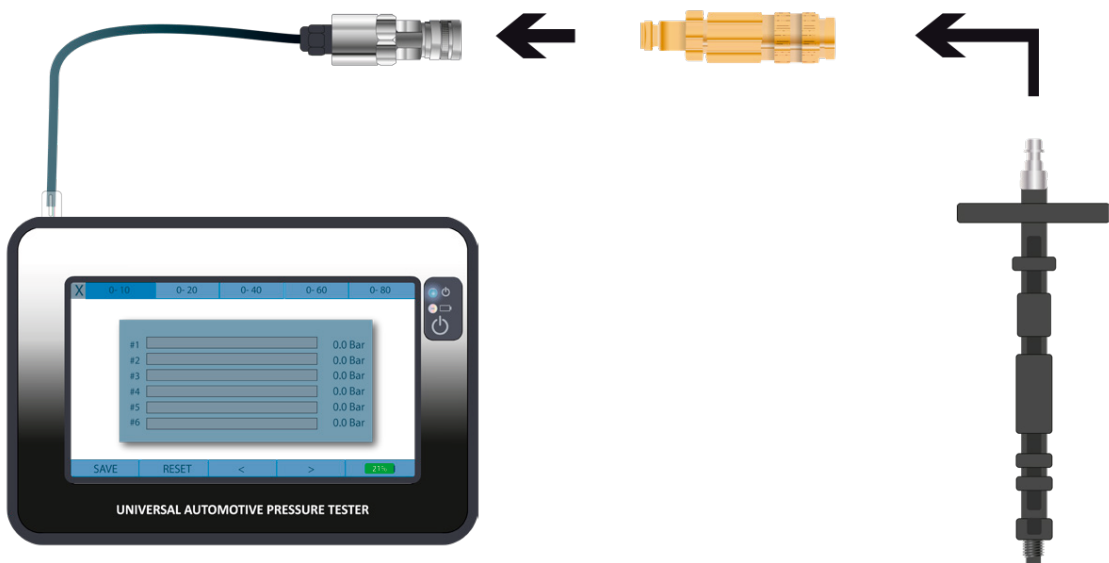

**REMARQUES :**

Vous pouvez accéder au logiciel windows grace au lien suivant :

Ou en allant sur notre site [clas.com](https://www.clas.com) et en recherchant la référence du produit en question

You can access the windows software through the following link:

Or by going to our website [clas.com](https://www.clas.com) and searching for the reference of the product



CLAS Equipements

83 Chemin de la CROUZA
73800 CHIGNIN
FRANCE

Tél. +33 (0)4 79 72 62 22
Fax. +33 (0)4 79 72 52 86

AC 0800

TESTEUR MULTI-PRESSIONS DIGITAL

DIGITAL MULTI-PRESSURE TESTER

Si vous avez besoin de composants ou de pièces, contactez le revendeur
En cas de problème veuillez contacter le technicien de votre distributeur agréé

If you need components or parts, please contact the reseller.
In case of problems, please contact your authorized technician.